

ЗАМЯНА САЛНИКОВА НАБИВКА С МЕХАНИЧНО ЧЕЛНО УПЛЪТНЕНИЕ

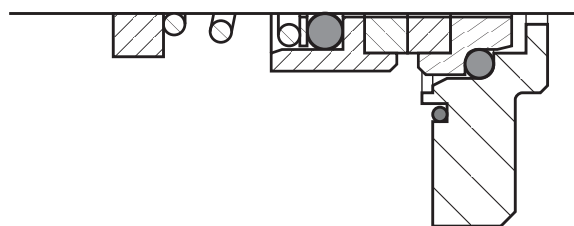

Тип D700 с хомут

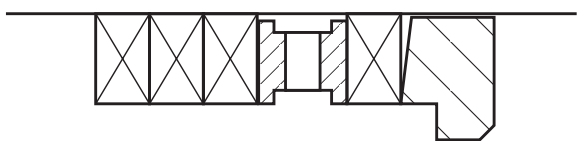
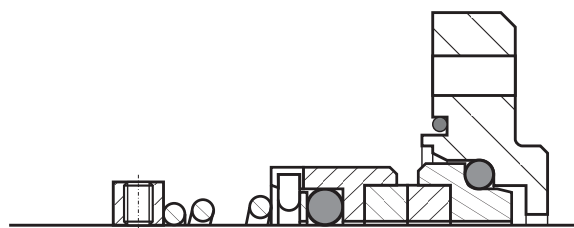
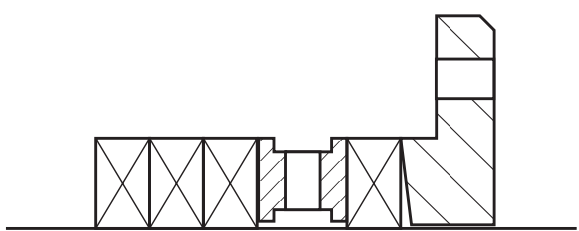
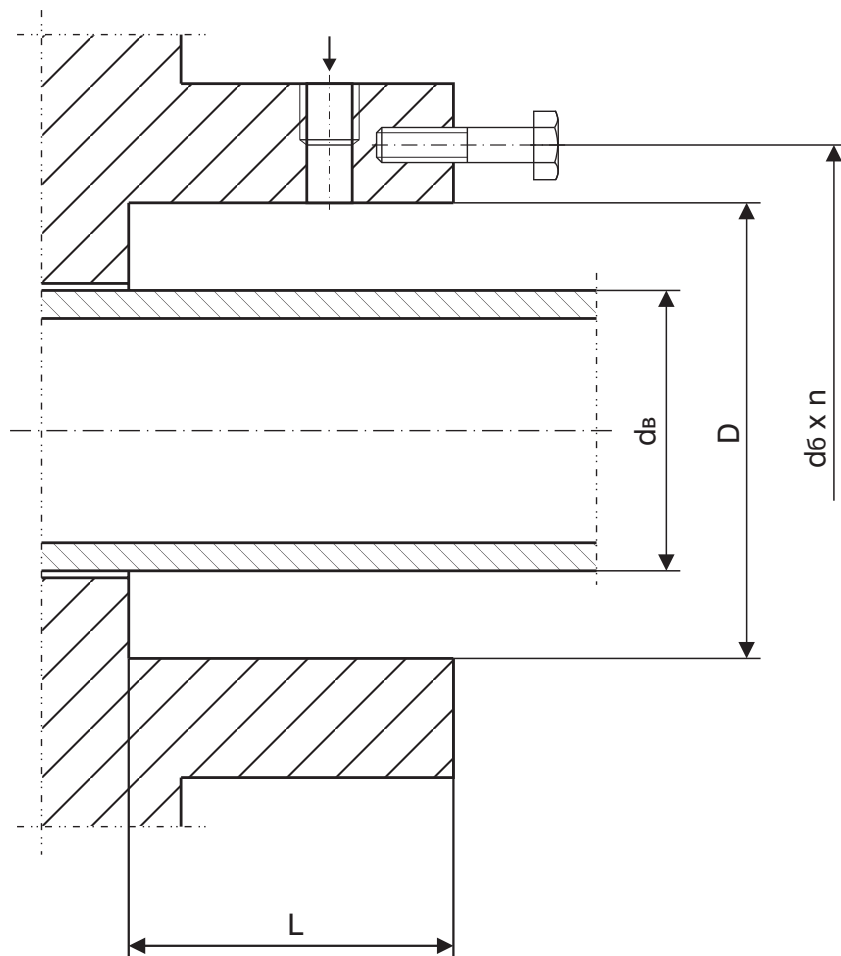
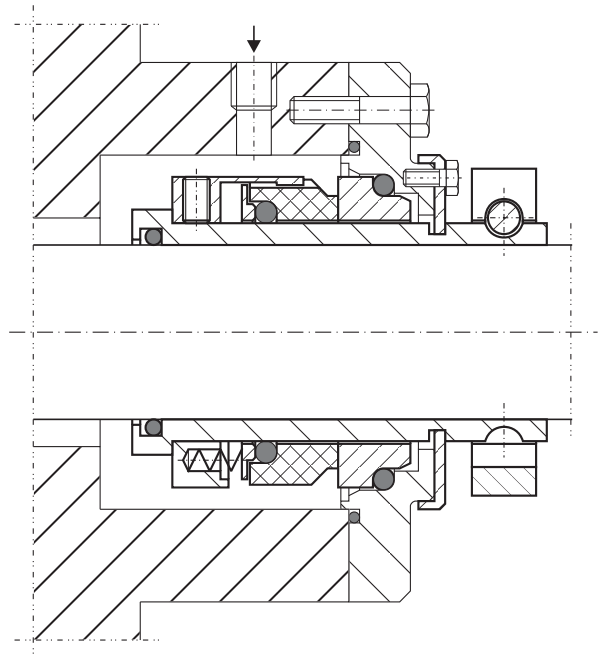
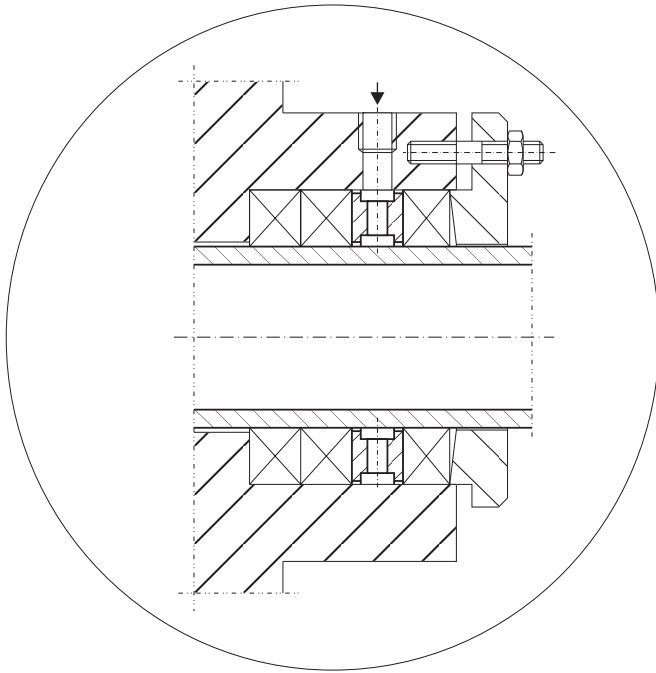

Тип D720

